



# TSW212

Ensured by PROFINET



# HARDWARE

## FRONT VIEW

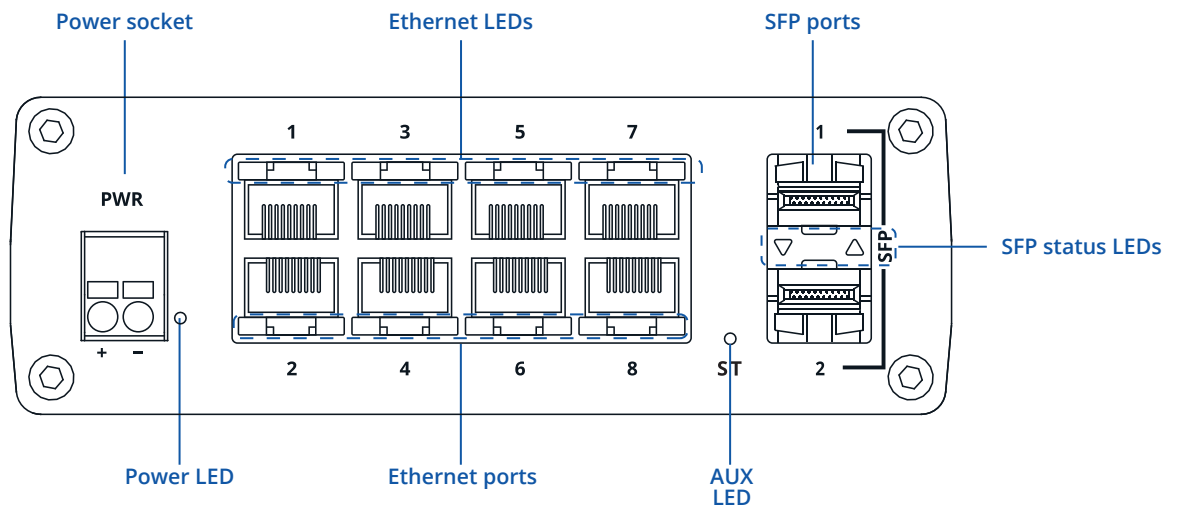

## BACK VIEW

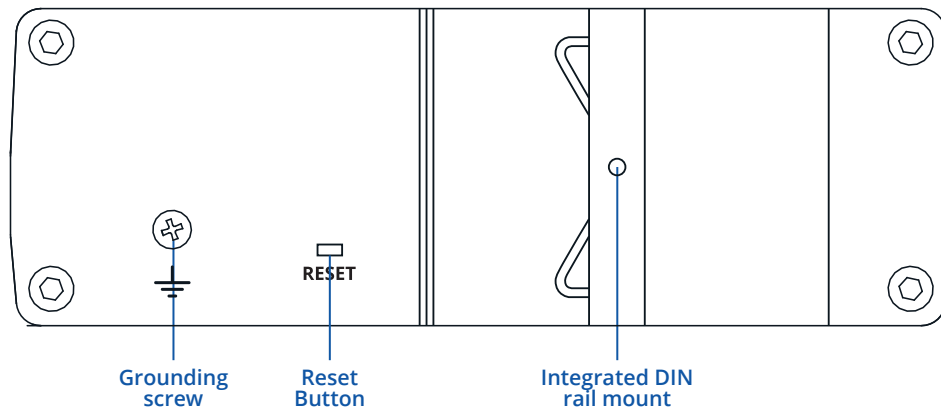

## RJ45 LED MEANING

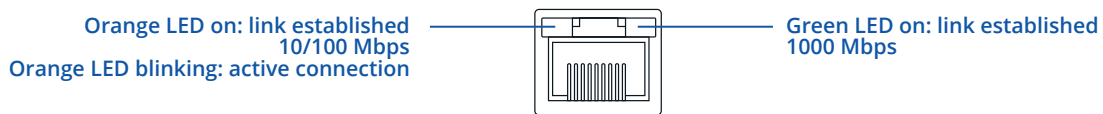

## POWER SOCKET PINOUT

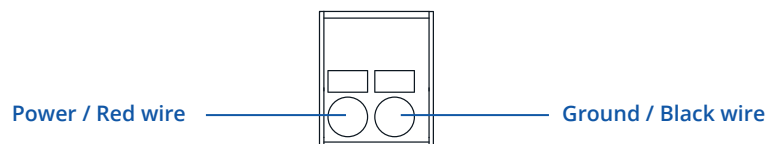

## SFP LED MEANING

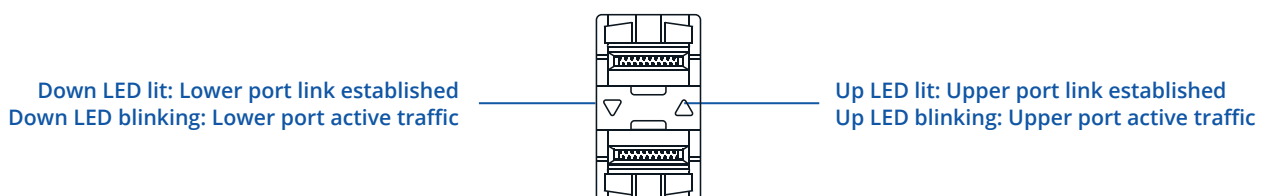

## FEATURES

### ETHERNET

ETH	Multi-layer managed 8 x ETH ports, 10/100/1000 Mbps supports auto MDI/MDIX crossover
Fibre	2 x SFP ports
IEEE 802.3 series standards	802.3i, 802.3u, 802.3ab, 802.3x

### SERVICES

EtherNet/IP	Yes
Profinet (class B)	Yes
SNMP V2, V3	Yes
LLDP	Yes

### NETWORK

MRP	MRP client role, MRP manager role
L2 features	Loop protection, Forwarding table, VLAN, STP/RSTP
DHCP	DHCP server, DHCP client
Port Settings	Enable/disable, link speed control, port isolation, EEE (802.3az) management, Port Mirroring
L3 Features	Static IPv4 routing, static IPv6 routing, DHCPv6 client, static IPv6 address

### QOS

QOS	Port priority, DSCP priority, 802.1p priority, TOS
Scheduling method	SP/WFQ/WRR
Bandwidth control	Rate limiting, storm control
Traffic Shaper	Port-based shaping

### DIAGNOSTICS

Tools	Cable diagnostic, ping, traceroute, nslookup
-------	--

### SYSTEM CHARACTERISTICS

RAM	128MB, DDR3
FLASH storage	16 MB serial flash

### FIRMWARE / CONFIGURATION

WEB UI	Update FW from file, check FW on server, configuration profiles, configuration backup
FOTA	Update FW
RMS	Update FW/configuration for multiple devices at once
Keep settings	Update FW without losing current configuration

### FIRMWARE CUSTOMISATION

Operating system	TSWOS (OpenWrt based Linux OS)
Supported languages	Busybox shell, Lua, C, C++
Development tools	SDK package with build environment provided

### PERFORMANCE SPECIFICATIONS

Bandwidth (Non-blocking)	20 Gbps
Forwarding rate	14.88 Mpps
Packet buffer	512 KB
MAC address table size	8K entries
Jumbo frame support	10000 bytes

**POWER**

Connector	2-pin industrial DC power socket
Input voltage range	7 - 57 VDC
Power consumption	Idle: < 2.5 W / Max: 6 W

**PHYSICAL INTERFACES**

Ethernet	8 x RJ45 ports, 10/100/1000 Mbps
Fibre	2 x SFP ports
Status LEDs	1 x Power LED, 1 x Aux LED, 16 x ETH status LEDs, 2 x SFP status LEDs
Power	1 x 2-pin industrial DC power socket
Reset	Software reset button
Grounding	1 x Grounding screw

**PHYSICAL SPECIFICATION**

Casing material	Anodized aluminum housing and panels
Dimensions (W x H x D)	132 x 44.2 x 122.2 mm
Weight	615 g
Mounting options	Integrated DIN rail bracket, wall mounting (additional kit needed), flat surface placement

**OPERATING ENVIRONMENT**

Operating temperature	-40 °C to 75 °C
Operating humidity	10 % to 90 % non-condensing
Ingress Protection Rating	IP30

**REGULATORY & TYPE APPROVALS**

Regulatory	CE, UKCA, RCM, ANRT, FCC, IC, CB, RoHS, REACH
------------	---

**EMC EMISSIONS & IMMUNITY**

Standards	EN 55032:2015 + A11:2020 + A1:2020 EN 55035:2017 + A11:2020 EN IEC 61000-3-2: 2019 + A1:2021 EN 61000-3-3: 2013 + A1:2019 + A2:2021
ESD	EN 61000-4-2:2009
Radiated Immunity	EN IEC 61000-4-3:2020
EFT	EN 61000-4-4:2012
Surge Immunity (AC Mains Power Port)	EN 61000-4-5:2014 + A1:2017
CS	EN 61000-4-6:2014
DIP	EN 61000-4-11:2020

**SAFETY**

Standards	CE: EN IEC 62368-1:2020 + A11:2020 RCM: AS/NZS 62368.1:2022 CB: IEC 62368-1:2018
-----------	--

## STANDARD PACKAGE\*

- TSW212
- QSG (Quick Start Guide)
- Packaging box



\* Standard package contents may differ based on standard order codes.

## CLASSIFICATION CODES

HS Code: 851762  
 HTS: 8517.62.00

For more information on all available packaging options – please contact us directly.

## AVAILABLE VERSIONS

HARDWARE VERSION	SUPPORTED FREQUENCIES	STANDARD ORDER CODE / PACKAGE CONTAINS
TSW212 *****	N/A	TSW212000000 / Standard package

# TSW212 SPATIAL MEASUREMENTS

## MAIN MEASUREMENTS

W x H x D dimensions for TSW212:

Device housing\*: 132 x 44.2 x 122.2 mm

Box: 125 x 136 x 47 mm

\*Housing measurements are presented without screws; for measurements of other device elements look to the sections below.

## TOP VIEW

The figure below depicts the measurements of TSW212 and its components as seen from the top:

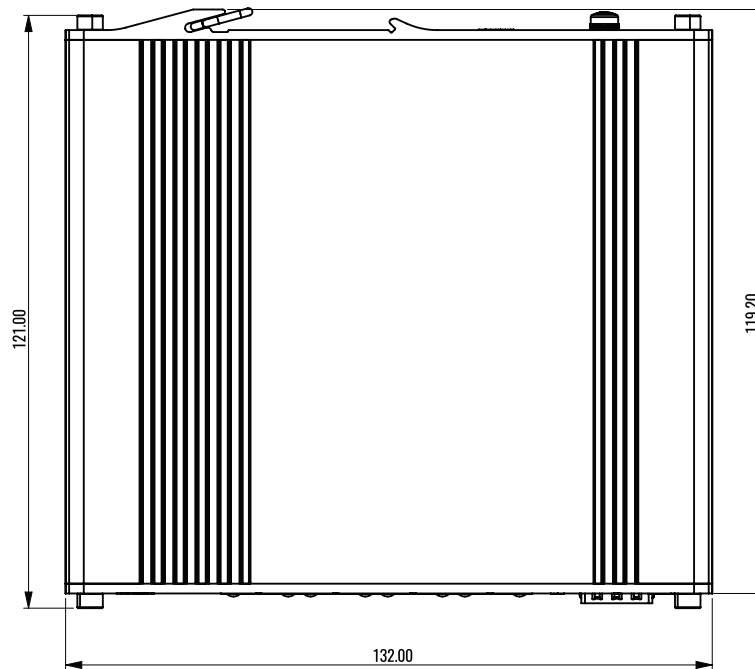

## RIGHT VIEW

The figure below depicts the measurements of TSW212 and its components as seen from the right side:

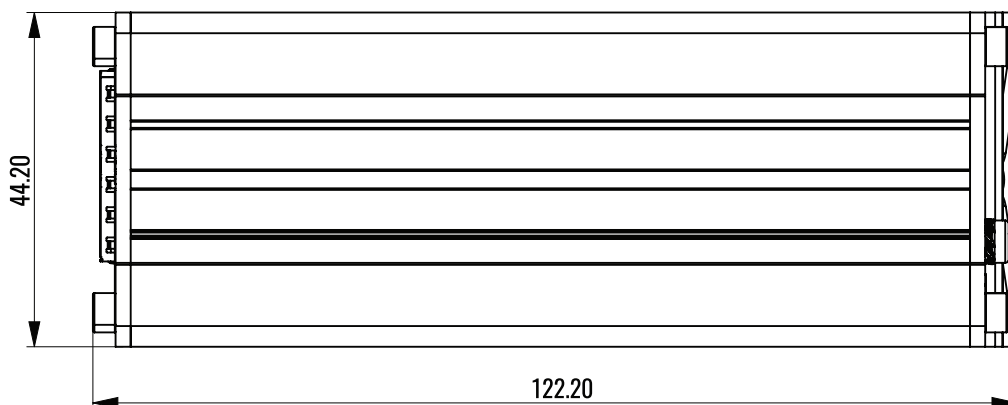

FRONT VIEW

The figure below depicts the measurements of TSW212 and its components as seen from the front panel side:

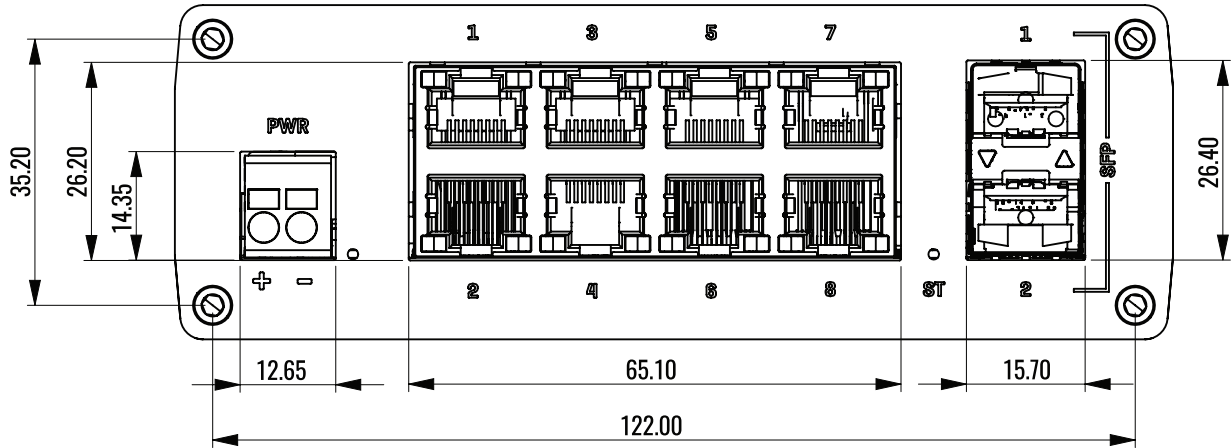

REAR VIEW

The figure below depicts the measurements of TSW212 and its components as seen from the back panel side:

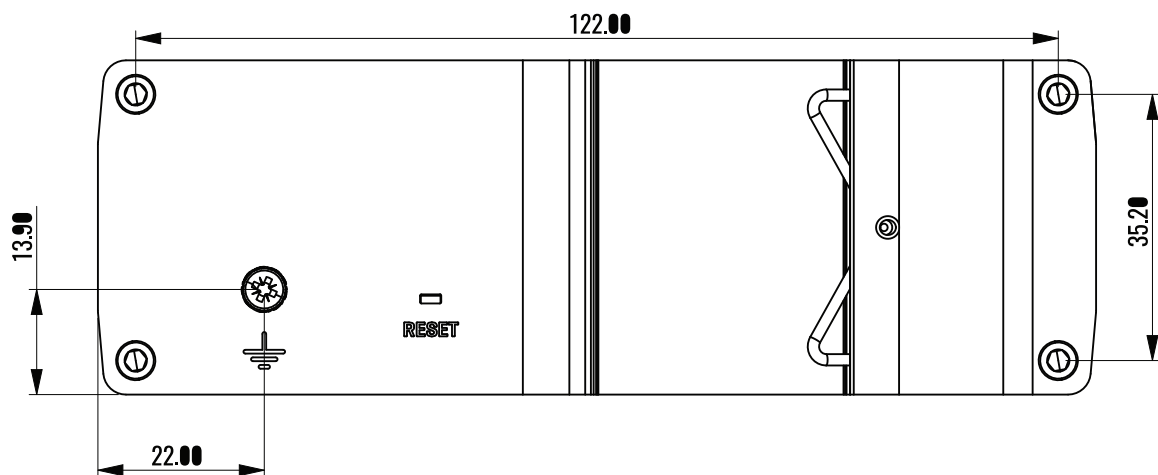

**MOUNTING SPACE REQUIREMENTS**

The figure below depicts an approximation of the device's dimensions when cables are attached:

